

STEEL WALL POOL SYSTEM

18' X 36' RECTANGLE - 2'R

DWG #: GS-11565-DB	DATE: 8/3/2023	REV: -	PAGE 1 OF 3
AREA (SqFt): 645	PERIMETER: 105'	EST. VOL (US Gal): TBD	

# 1836 RECTANGLE INGROUND KIT

**STRAIGHT STEP OPTION**

SEE INSTALL GUIDE FOR INSTALLATION

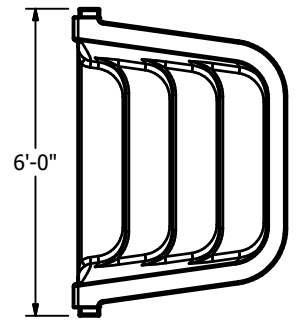

K2FS-1836T26SB - BLUE  
 K2FS-1836T26SG - GREY  
 K2FS-1836T26SW - WHITE

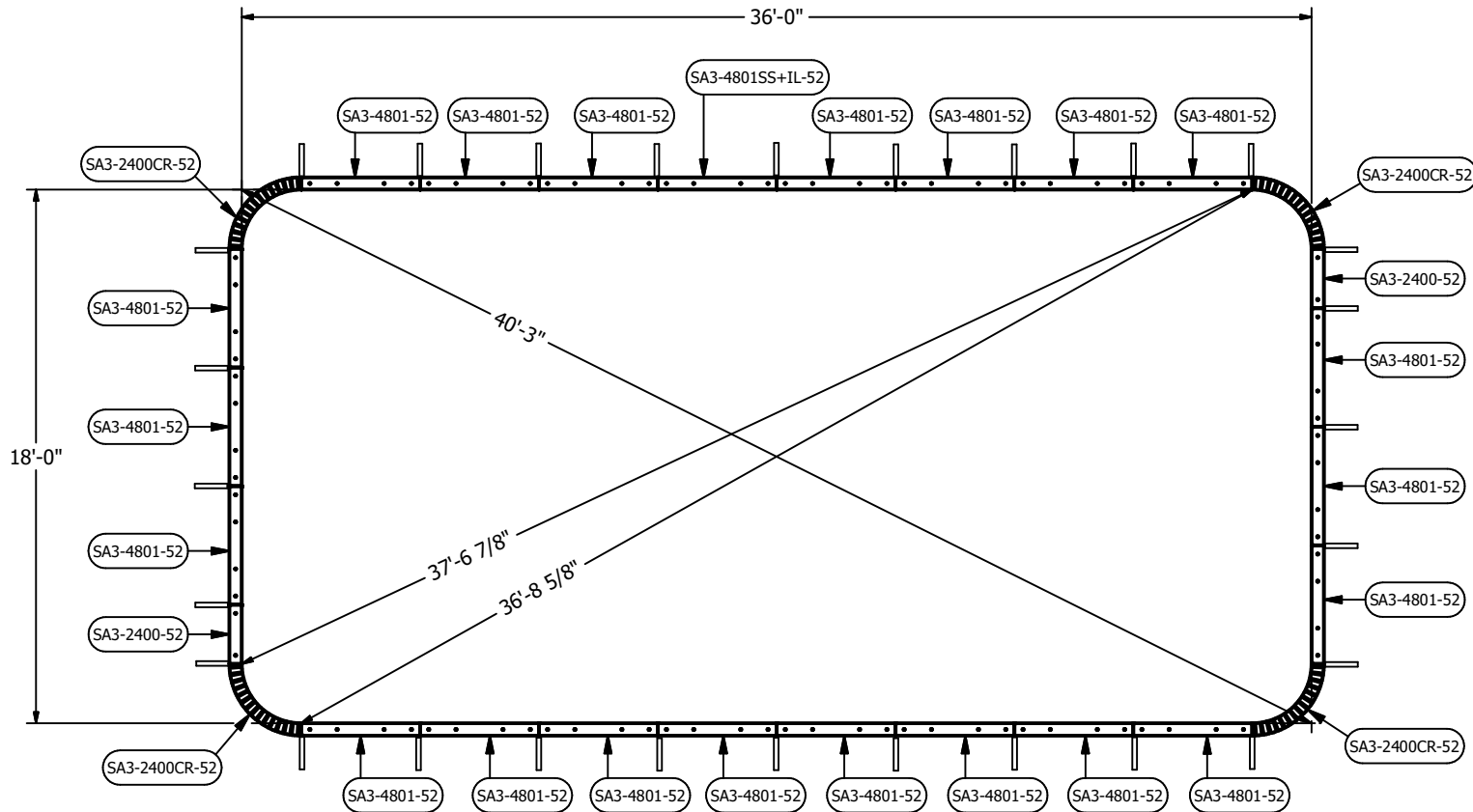

BILL OF MATERIALS		
QTY	PART NUMBER	DESCRIPTION
2	SA3-2400-52	Stl Pnl 24" Plain
4	SA3-2400CR-52	Stl Pnl 2'R Corner
21	SA3-4801-52	Stl Pnl 48"x42" Plain - 1 Rib
1	SA3-4801SS+IL-52	Stl Pnl 48" Skim(1084)+Inlet Lft (52" Tall)

BRACE / HARDWARE OPTIONS		
QTY	PART NUMBER	DESCRIPTION
28	ST-1020ENB-52	Stl Brc Embedded Nut Brace+Stake
48	ST-1012DK	Stl Brc Drive Stake (1 Piece)
1	HW-2002	Hdw Steel/Rrd Kit
4	HW-2013	Hdw Steel Add-on Kit (3/8" Bolts-100, 3/8" Nuts-100)

COPING		
QTY	PART NUMBER	DESCRIPTION
1	HW-2012	Hdw No-Diving Plate(7/Bag)
1	HW-1007	Hdw 12x1" Tek Screws - 100/Box
1	ATG-1001G	Alu Txt Clips - Grey - 15/Bag
2	ATG-9606G	Alu Txt 8' Bull Std-Str Grey-6/Box
1	ATG-2404CRG	Alu Txt 2'R Bullnose Std - Corner Grey -4/Box

**NO DIVING** DANGER: DIVING MAY RESULT IN SERIOUS INJURY OR DEATH. Signage must be permanently attached around the perimeter of the pool.

THIS DOCUMENT IS FOR ILLUSTRATIVE PURPOSES ONLY. Original Equipment Manufacturer makes only those representations which are stated in its written warranty. Any other representations, statements, or contracts made by the dealer/contractor to the customer regarding any components produced by Original Equipment Manufacturer are attributable to the dealer/contractor only. The dealer or contractor who sells or installs your pool is an independent contractor and is not an agent or employee of Original Equipment Manufacturer. The construction methods illustrated here are suggestions and apply only to normal ground conditions. There may be additional precautions and/or methods of construction. The responsibility is the contractor's. -A safety line, with buoys, is to be permanently attached 1'-0" to the shallow side of the point of first slope change. -Different methods and precautions may be dictated by various ground conditions. This is to be determined by and is the responsibility of the contractor who is not an agent of the manufacturer of the component parts. -Installation is to be done in accordance with all federal, state and local building codes, as well as A.N.S.I./N.S.P.I. suggested standards. -BOTTOM SPECIFICATIONS MUST MEET OR EXCEED A.N.S.I./N.S.P.I./A.P.S.P. RECOMMENDED STANDARDS -NO DIVING signage must be permanently attached to the entire perimeter of the pool. See instructions with signage. -IT IS RECOMMENDED TO NOT INSTALL DIVING BOARDS AND/OR SLIDING EQUIPMENT ON RESIDENTIAL POOLS. IF diving boards and/or sliding equipment is installed by the contractor, such diving boards and sliding equipment MUST BE INSTALLED WITHIN THE GUIDELINES ESTABLISHED BY ANSI/NSPI/ASPA RECOMMENDED STANDARDS, AND IN ACCORDANCE WITH ALL APPLICABLE STATE AND LOCAL CODES AND REGULATIONS.



STEEL WALL POOL SYSTEM

18' X 36' RECTANGLE - 2'R

DWG #: GS-11565-DB DATE: 8/3/2023 REV: - PAGE 2 OF 3

AREA (SqFt): 645 PERIMETER: 105' EST. VOL (US Gal): TBD

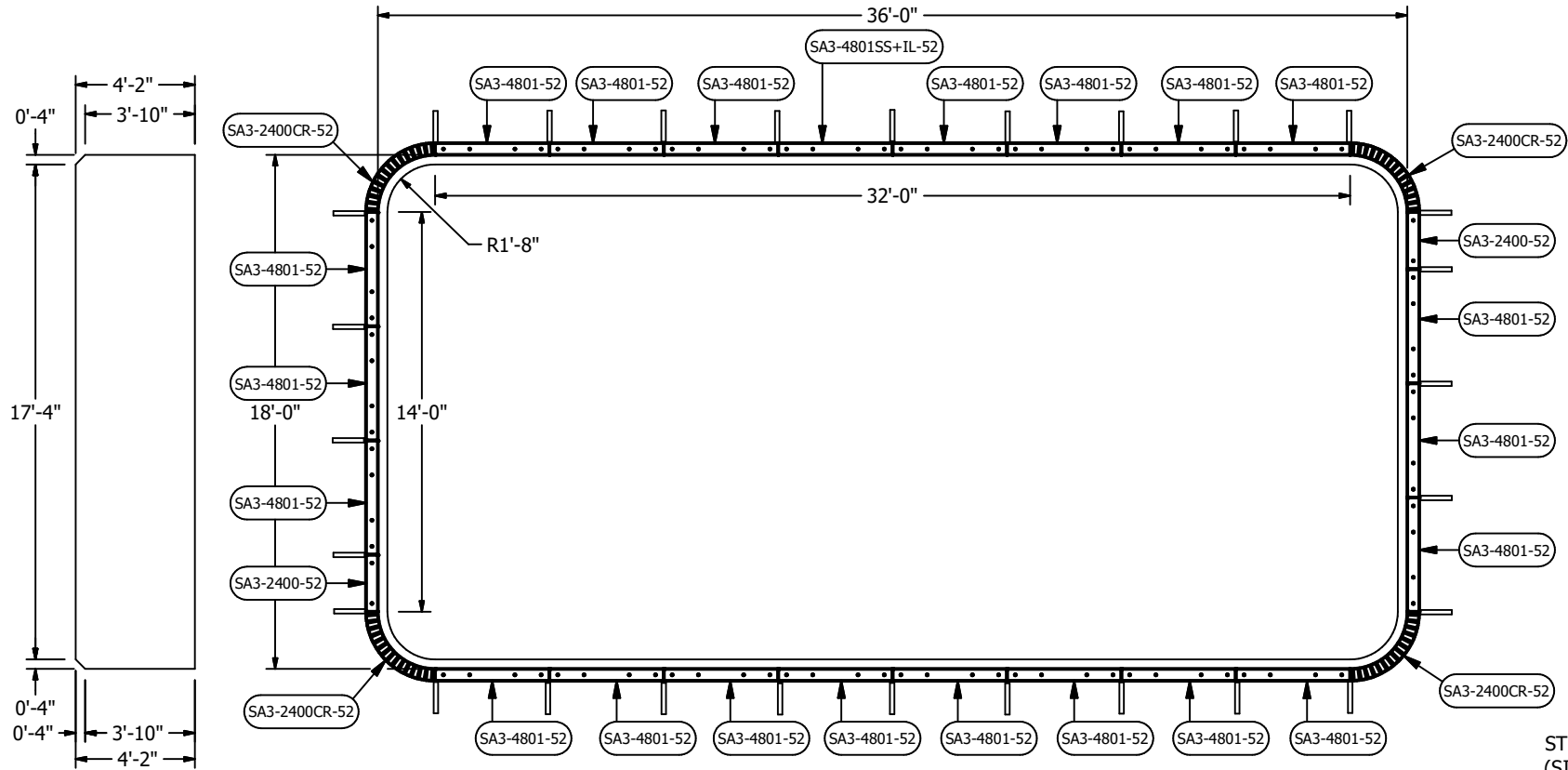

ST-1020ENB-52 (SIDE PROFILE)

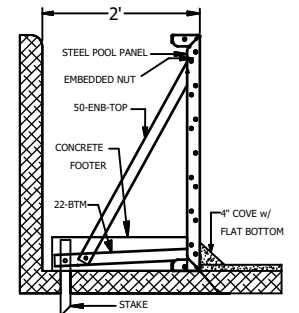
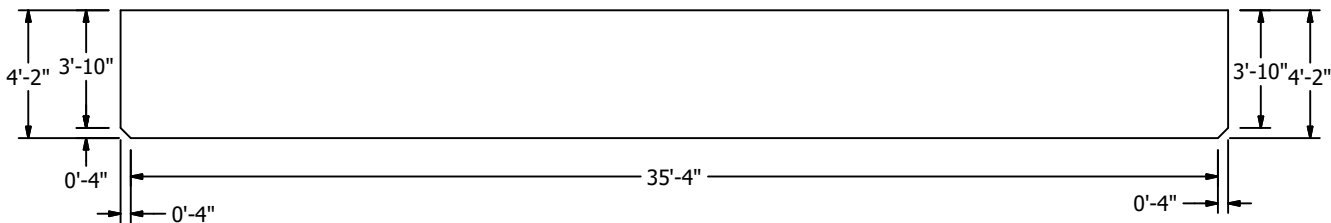

**NO DIVING** DANGER: DIVING MAY RESULT IN SERIOUS INJURY OR DEATH. Signage must be permanently attached around the perimeter of the pool.

THIS DOCUMENT IS FOR ILLUSTRATIVE PURPOSES ONLY. Original Equipment Manufacturer makes only those representations which are stated in its written warranty. Any other representations, statements, or contracts made by the dealer/contractor to the customer regarding any components produced by Original Equipment Manufacturer are attributable to the dealer/contractor only. The dealer or contractor who sells or installs your pool is an independent contractor and is not an agent or employee of Original Equipment Manufacturer. The construction methods illustrated here are suggestions and apply only to normal ground conditions. There may be additional precautions and/or methods of construction. The responsibility is the contractor's. -A safety line, with buoys, is to be permanently attached 1'-0" to the shallow side of the point of first slope change. -Different methods and precautions may be dictated by various ground conditions. This is to be determined by and is the responsibility of the contractor who is not an agent of the manufacturer of the component parts. -Installation is to be done in accordance with all federal, state and local building codes, as well as A.N.S.I./N.S.P.I. suggested standards. -BOTTOM SPECIFICATIONS MUST MEET OR EXCEED A.N.S.I./N.S.P.I./A.P.S.P. RECOMMENDED STANDARDS. -NO DIVING signage must be permanently attached to the entire perimeter of the pool. See instructions with signage. -IT IS RECOMMENDED TO NOT INSTALL DIVING BOARDS AND/OR SLIDING EQUIPMENT ON RESIDENTIAL POOLS. IF diving boards and/or sliding equipment is installed by the contractor, such diving boards and sliding equipment MUST BE INSTALLED WITHIN THE GUIDELINES ESTABLISHED BY ANSI/NSPI/ASPA RECOMMENDED STANDARDS, AND IN ACCORDANCE WITH ALL APPLICABLE STATE AND LOCAL CODES AND REGULATIONS.



STEEL WALL POOL SYSTEM

18' X 36' RECTANGLE - 2'R

DWG #: GS-11565-DB	DATE: 8/3/2023	REV: -	PAGE 3 OF 3
AREA (SqFt): 645	PERIMETER: 105'	EST. VOL (US Gal): TBD	

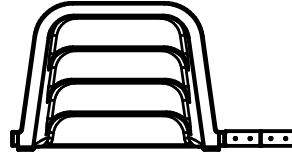

K2FS-1836T26SB - BLUE  
 K2FS-1836T26SG - GREY  
 K2FS-1836T26SW - WHITE  
 (KIT CONTAINS x2 SA3-1200-52 PANELS WHICH CAN BE USED IN COMBINATION TO ACCOMMODATE 6' STEP)

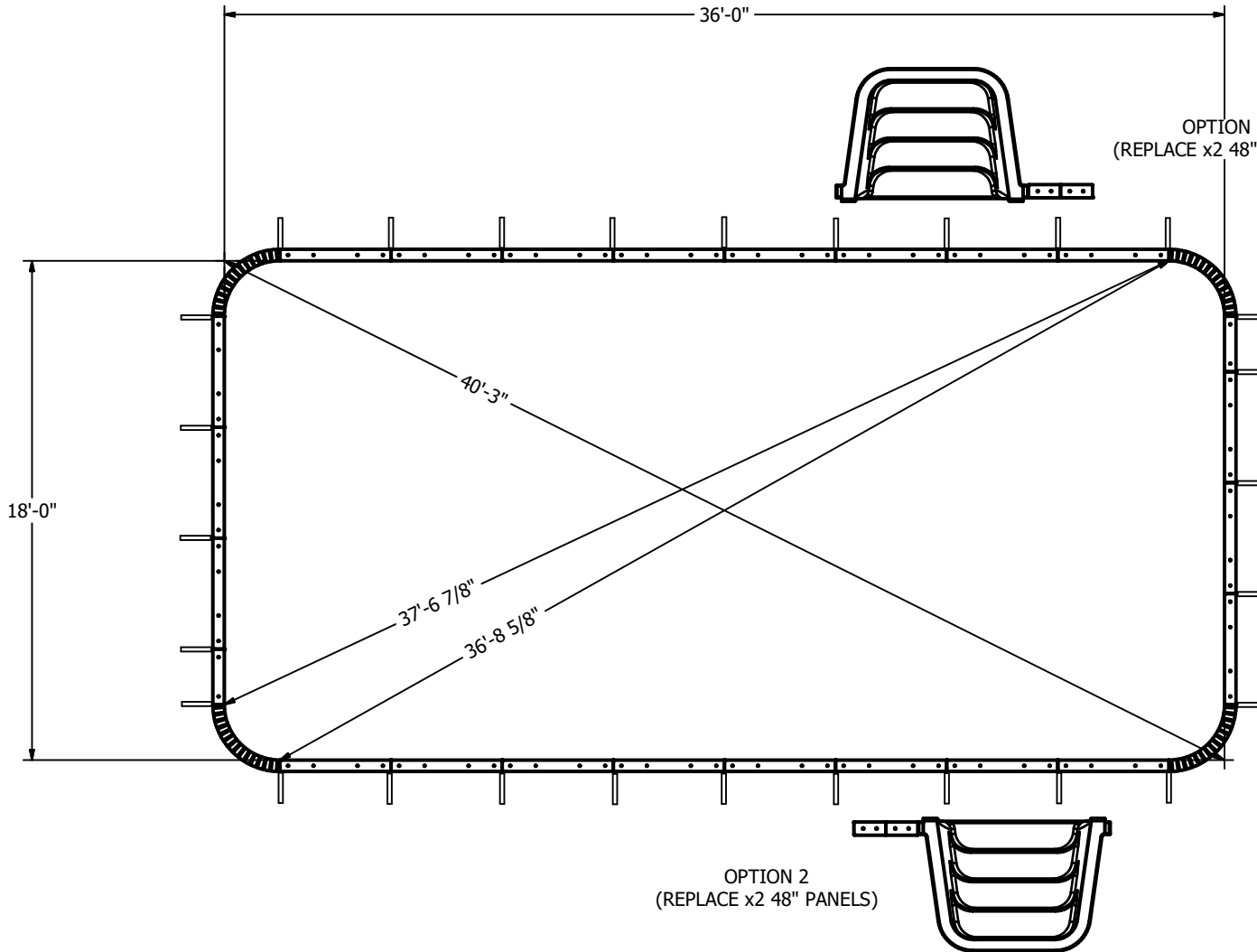

OPTION 2  
 (REPLACE x2 48" PANELS)

OPTION 2  
 (REPLACE x2 48" PANELS)

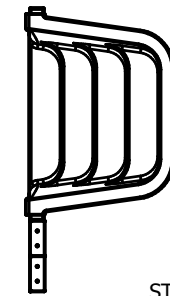

ST-1020ENB-52  
 (SIDE PROFILE)

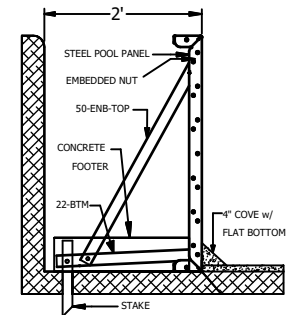

OPTION 2  
 (REPLACE x2 48" PANELS)

**NO DIVING** DANGER: DIVING MAY RESULT IN SERIOUS INJURY OR DEATH. Signage must be permanently attached around the perimeter of the pool.

THIS DOCUMENT IS FOR ILLUSTRATIVE PURPOSES ONLY. Original Equipment Manufacturer makes only those representations which are stated in its written warranty. Any other representations, statements, or contracts made by the dealer/contractor to the customer regarding any components produced by Original Equipment Manufacturer are attributable to the dealer/contractor only. The dealer or contractor who sells or installs your pool is an independent contractor and is not an agent or employee of Original Equipment Manufacturer. The construction methods illustrated here are suggestions and apply only to normal ground conditions. There may be additional precautions and/or methods of construction. The responsibility is the contractor's. -A safety line, with buoys, is to be permanently attached 1'-0" to the shallow side of the point of first slope change. -Different methods and precautions may be dictated by various ground conditions. This is to be determined by and is the responsibility of the contractor who is not an agent of the manufacturer of the component parts. -Installation is to be done in accordance with all federal, state and local building codes, as well as A.N.S.I./N.S.P.I. suggested standards. -BOTTOM SPECIFICATIONS MUST MEET OR EXCEED A.N.S.I./N.S.P.I./A.P.S.P. RECOMMENDED STANDARDS. -NO DIVING signage must be permanently attached to the entire perimeter of the pool. See instructions with signage. -IT IS RECOMMENDED TO NOT INSTALL DIVING BOARDS AND/OR SLIDING EQUIPMENT ON RESIDENTIAL POOLS. If diving boards and/or sliding equipment is installed by the contractor, such diving boards and sliding equipment MUST BE INSTALLED WITHIN THE GUIDELINES ESTABLISHED BY ANSI/NSPI/ASPA RECOMMENDED STANDARDS, AND IN ACCORDANCE WITH ALL APPLICABLE STATE AND LOCAL CODES AND REGULATIONS.

